

KENWOOD

PORTABLE COMPACT DISC PLAYER

DPC-361

INSTRUCTION MANUAL

KENWOOD CORPORATION

For your records

Record the serial number, found on the back of the unit, in the spaces designated on the warranty card, and in the space provided below. Refer to the model and serial numbers whenever you call upon your dealer for information or service on the product.

Model _____ Serial Number _____

Unpacking

Unpack the unit carefully and make sure that all accessories are put aside so they will not be lost.

Examine the unit for any possibility of shipping damage. If your unit is damaged or fails to operate, notify your dealer immediately. If your unit was shipped to you directly, notify the shipping company without delay. Only the consignee (the person or company receiving the unit) can file a claim against the carrier for shipping damage.

We recommend that you retain the original carton and packing materials for use should you transport or ship the unit in the future.

Before using the rechargeable battery pack (optional)

The optional rechargeable battery pack is sold in the non-charged condition. Read "Battery powered operation" carefully and charge the battery before use.

COMPACT
disc
DIGITAL AUDIO

B60-2302-18 (S) (K, P, M, X, T) MC
96/12 11 10 9 8 7 6 5 4 3 2 1 95/12 11 10 9 8 7 6 5 4

Various playback features

Pressing the REPEAT key in the play or stop mode allows you to enjoy various playback features.

Press the REPEAT key.



Each press switches the repeat modes as follows.

➔ **1 One-track repeat**

The track being played or selected track will be played repeatedly.



2 All-track repeat

All tracks on the disc will be played repeatedly.



3 Shuffle play

All tracks on the disc will be played in a random order.



4 Scan play

A part of every track on the disc will be played for 20 seconds.
(Fast forward or fast reverse operation is not possible.)



5 Canceled position

Returns the normal play mode.



- Shuffle play cannot be selected while the programmed playback is activated.

HOLD switch

The operation keys of the main volume control are defeated. This position prevents undesirable use, e.g., a bag, etc.

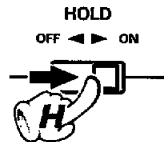

Set to the right position.

- Before operating the unit in any position other than the HOLD position while the switch is in





Dear Customer:

Selecting fine audio equipment such as the unit you've just purchased is only the start of your musical enjoyment. Now it's time to consider how you can maximize the fun and excitement your equipment offers. This manufacturer and the Electronic Industries Association's Consumer Electronics Group want you to get the most out of your equipment by playing it at a safe level. One that lets the sound come through loud and clear without annoying blaring or distortion—and, most importantly, without affecting your sensitive hearing.

Sound can be deceiving. Over time your hearing "comfort level" adapts to higher volumes of sound. So what sounds "normal" can actually be loud and harmful to your hearing. Guard against this by setting your equipment at a safe level BEFORE your hearing adapts.

To establish a safe level:

- Start your volume control at a low setting.
- Slowly increase the sound until you can hear it comfortably and clearly, and without distortion.

Once you have established a comfortable sound level:

- Set the dial and leave it there.

Taking a minute to do this now will help to prevent hearing damage or loss in the future. After all, we want you listening for a lifetime.

We Want You Listening For A Lifetime

Used wisely, your new sound equipment will provide a lifetime of fun and enjoyment. Since hearing damage from loud noise is often undetectable until it is too late, this manufacturer and the Electronic Industries Association's Consumer Electronics Group recommend you avoid prolonged exposure to excessive noise. This list of sound levels is included for your protection.

Decibel

Level Example

30	Quiet library, soft whispers
40	Living room, refrigerator, bedroom away from traffic
50	Light traffic, normal conversation, quiet office
60	Air conditioner at 20 feet, sewing machine
70	Vacuum cleaner, hair dryer, noisy restaurant
80	Average city traffic, garbage disposals, alarm clock at two feet.

THE FOLLOWING NOISES CAN BE DANGEROUS UNDER CONSTANT EXPOSURE

90	Subway, motorcycle, truck traffic, lawn mower
100	Garbage truck, chain saw, pneumatic drill
120	Rock band concert in front of speakers, thunderclap
140	Gunshot blast, jet plane
180	Rocket launching pad

Information courtesy of the Deafness Research Foundation.

For the U.S.A.**FCC WARNING:**

This equipment may generate or use radio frequency energy. Changes or modifications to this equipment may cause harmful interference unless the modifications are expressly approved in the instruction manual. The user could lose the authority to operate this equipment if an unauthorized change or modification is made.

NOTE:

This equipment has been tested and found to comply with the limits for a CLASS B digital device, pursuant to Part 15 of the FCC Rules. These limits are designed to provide reasonable protection against harmful interference in a residential installation. This equipment may cause harmful interference to radio communications, if it is not installed and used in accordance with the instructions. However, there is no guarantee that interference will not occur in a particular installation. If this equipment does cause harmful interference to radio or television reception, which can be determined by turning the equipment off and on, the user is encouraged to try to correct the interference by one or more of the following measures:

- Reorient or relocate the receiving antenna.
- Increase the separation between the equipment and receiver.
- Connect the equipment into an outlet on a circuit different from that to which the receiver is connected.
- Consult the dealer or an experienced radio/TV technician for help.

**For CANADA
DOC REGULATION**

"This digital apparatus does not exceed the CLASS B limits for radio noise emissions from digital apparatus as set out in the radio interference regulations of the Canadian Department of Communications."

The marking of products using lasers (Except for some areas).

**CLASS 1
LASER PRODUCT**

This label is attached to the bottom panel and says that the component uses laser beams that have been classified as Class 1. It means that the unit is utilizing laser beams that are of a weaker class. There is no danger of hazardous radiation outside the unit.

WARNING: TO PREVENT FIRE OR ELECTRIC SHOCK, DO NOT EXPOSE

IMPORTANT SAFEGUARDS

Please read all of the safety and operating instructions before operating this unit. For best results. These safety and operating instructions should be retained for future reference.

- 1. Power sources** — The unit should be connected to a power supply only of the type described in the operating instructions or as marked on the appliance.
- 2. Power-cord protection** — Power-supply cords should be routed so that they are not likely to be walked on or pinched by items placed upon or against them, pay particular attention to cords at plugs, convenience receptacles, and the point where they exit from the unit.
- 3. Enclosure removal** — Never remove the enclosure. If the internal parts are touched accidentally, a serious electric shock might occur.
- 4. Drop** — Do not drop the unit or apply strong shock to it. (Damage due to dropping the unit is not covered by the warranty.)
- 5. Ventilation** — Avoid hindering the ventilation of the unit by covering it with a cloth, etc.
- 6. Abnormal smell** — If an abnormal smell or smoke is detected, immediately turn the power OFF and pull out the power cord. Contact your dealer or nearest service center.
- 7. Heat** — Avoid placing the unit under direct sunlight or near a source of heat such as heating equipment. Particularly, never leave it in an automobile or on the dashboard.
- 8. Temperature** — The unit may not function properly if used at extremely low, or freezing temperatures. The ideal ambient temperature is above +5°C (41°F).
- 9. Water and moisture** — The unit should not be used near water — for example, near a bathtub, washbowl, kitchen sink, laundry tub, in a wet basement, or near a swimming pool, etc.
- 10. Dust and moisture** — Avoid places where is dusty or where the humidity is high.
- 11. Vibrations** — Avoid placing the unit on an unstable place such as a shelf or in a place subject to vibrations.
- 12. Magnetic fields** — Keep the unit away from sources of magnetic fields such as TV sets, speaker systems, radios, motorized toys or magnetized objects.

ents is of before connecting the cords.

DPC-361 (En)

If sound is not produced, change the tape playing direction of the car stereo.

(Sound is not produced if the car stereo is set to play tape side B.)

The sound reproduction may not be possible with some car stereo models.

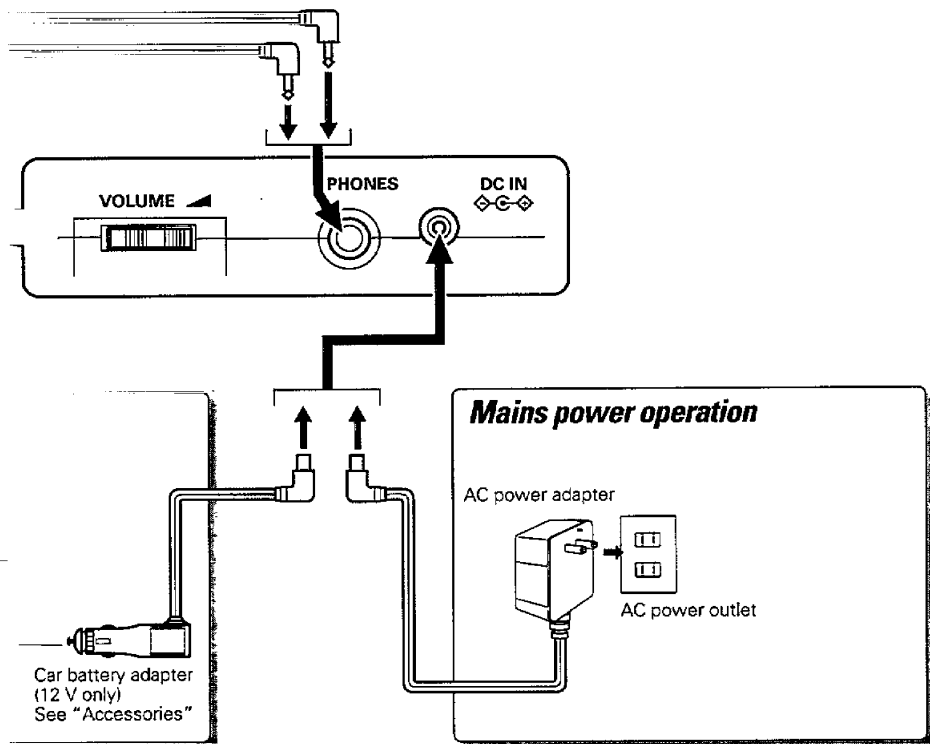

Playback from the first track

1 Set the HOLD switch to OFF.

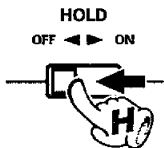

- Before any operation, be sure to set the HOLD switch to the OFF position.

2 Connect headphones.

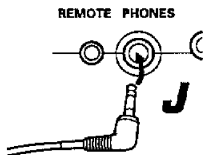

- Use headphones equipped with a stereo mini-plug.

3 Open the top cover.



4 Place a disc.

Place with labeled side up.

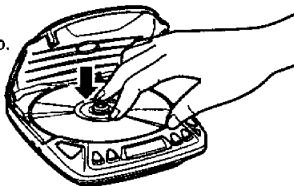

- Secure the disc by pushing a position near the center hole until it clicks.

5 Close the top cover.

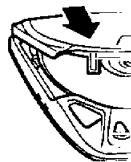

- Close securely by pushing the front cover until it clicks.

6 Start playback.



- The power comes ON and playback starts.
- Press P.MODE key during playback to return to the current track. Press again to return to the first track.

7 Adjust the volume.

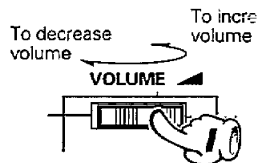

desired tracks can be played in the desired order.

track numbers in to play them.

Display when track No. 3
is selected in program 1



order by repeating ① and ② above.
played at a time.

To check the programmed contents

- ① Start playback.
- ② Press the SKIP/SEARCH key.



- Every time the SKIP/SEARCH key is pressed, the track numbers in the program are displayed in the order they were programmed.

To clear the program

Press the ■ key twice.



- Opening the lid cancels the program.

Battery powered operation

This unit can be powered
needed for car battery or
if the unit is not to be us

Rechargeable battery operation

(Only the rechargeable battery packs specified by KENWOOD can be used.)

Be always sure to use the optional rechargeable battery pack of NB-88 or NB-77. Never use other. Recharging completes in about 8 hours.

- ❶ Insert rechargeable batteries paying attention to the ⊕ and ⊖ polarity.

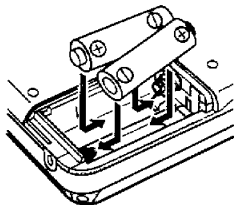

- Recharging is not possible during power OFF before starting recharging.
- The rechargeable batteries can be recharged about 500 times. When the product is purchased, the optional NB-88/NB-77 should be purchased.
- Be sure to close the top cover after recharging.

- ❷ Start recharging.

(1) Set the power OFF.

(2) Plug in the AC adapter.



- When using a rechargeable battery, the recharging time may be shorter than normal. This is not a malfunction. After recharging, the unit's performance can be recovered by recharging.
- Recharging completes in about 8 hours for more than 8 hours.

- ❸ After recharging, unplug the AC adapter from this unit.

Blinking timing of battery indicator

The timing in which the battery indicator starts to blink is variable depending on the type of battery used. Refer to the table on the right.

Battery indicator



Battery
Rechargeable battery
Dry cell battery

Maintenance

DPC-361 (En)

Simple care

Care of lens

When the lens in the pick-up gets dirty, malfunctions including the impossibility of playback may occur. The lens should be cleaned using a commercially-available camera lens blower, etc. Do not touch the lens to prevent damaging the mechanism. Also do not use a lens cleaner or disc cleaner product.

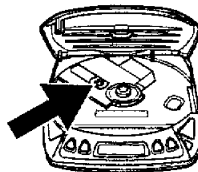

Care of main unit

When the unit gets dirty, clean with a soft, dry cloth. If the unit is stained seriously, a moistened cloth can be used. Do not use benzine or thinner for these will damage the unit.

Cleaning the plug

Wipe the headphone plug with a soft cloth to keep clean. A dirty plug may cause noise or malfunction.

Caution on disc used

Usable discs

This unit is capable of playing discs marked with . Other discs cannot be played. 8 cm single CDs can be played as they are; do not use a commercially-available single CD adapter.

Handling

Hold compact discs so that you do not touch the playing surface.

Do not attach paper or tape to either the playing side or the label side of compact discs.

Never play a cracked or warped disc.

During playback, the disc rotates at high speed in the player. Therefore, to avoid danger, never use a cracked or deformed disc or a disc repaired with tape or adhesive agent.

Cleaning

If fingerprints or foreign matter become attached to the disc, lightly wipe the disc with a soft cotton cloth (or similar) from the center of the disc outwards in a radial manner.

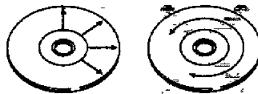

Storage

When a disc is not to be played for a long period of time, remove it from the CD player and store it in its case.

Precaution against condensation

Immediately after a room is heated or in a room with high humidity (or vapor), the unit may malfunction due to the condensation of dew or mist on the pick-up lens. In such a case, leave the unit for about an hour before trying to use it again.

To pause playback ⏸:



- When the ►/|| key is pressed rarely. Pressing the key again

To stop playback ⏹:



- The total number of tracks and be displayed.

Compensation of low

The low frequencies sound will be boosted.

BASS BOOST
OFF ◀▶ ON

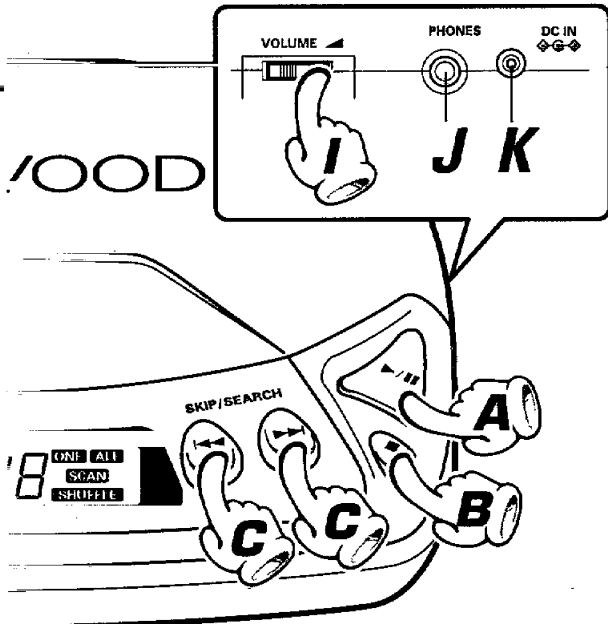

F OPEN key

Press to open the top cover.

G BASS BOOST switch

Switch to activate low-frequency compensation.

H HOLD switch

Set to switch the hold function ON and OFF.

I VOLUME control

Turn to adjust the listening level.

J PHONES (Headphones) jack

K DC IN jack

Temporarily



Blinks.

During playback, it pauses temporarily and resumes playback.



the total playing time of them will

frequencies

which is felt in headphone can be

ON

Low frequencies are boosted.

OFF

Normal tone reproduction.

Track selection by track skip

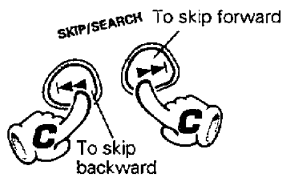

- The same number of tracks as the times the key is pressed can be skipped.
- When the **◀◀** key is pressed once during playback, the played position returns to the beginning of the current track being played.

Fast forward, fast reverse

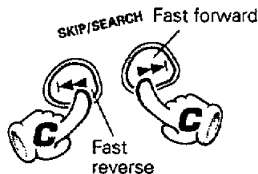

Hold the key pressed during playback.

- Playback resumes from the position where the key is released.
- If the key is released immediately after it has been pressed, the same operation as the track skip operation occurs.
- Fast forward and fast reverse operations are not possible during scan playback.

To turn power OFF

After stopping playback, press the **■** key again.



Auto power-Off function

If no operation key has been pressed for 2 minutes while the unit is in the stop mode, the power is turned OFF automatically to prevent battery power consumption.

Before applying power ⚠ Caution: Read this section carefully to ensure safe operation.

Units are designed for operation as follows.

U.S.A. and Canada ***AC 120 V only***
Australia ***AC 240 V only***
Europe and U.K. ***AC 230 V only***
Other countries ***AC 110-120 / 220 -240 V switchable***

****AC voltage selection***

AC adaptor shipped to countries other than the above are equipped with an AC voltage selector switch on the bottom cover. Refer to the following paragraph for the proper setting of this switch. AC adaptor operates on 110-120 volts or 220-240 volts AC. Before connecting the power cord to your AC outlet, make sure that the setting position of this switch matches your line voltage. If not, it must be set to your voltage in accordance with the following direction.

Note:

Our warranty does not cover damage caused by excessive line voltage due to improper setting of the AC voltage selector switch.

AC voltage selector switch



The AC adaptor is provided with a voltage selector switch which has been preset for 220-240 V. If using it with 110-120V power, switch to the 110-120V position.

from three kinds of power supplies; batteries, mains power or car battery. (The car battery adapter is not included.) When using batteries, use alkaline batteries or rechargeable batteries. For a long period (for more than one week), remove the batteries out of the unit.

than specified battery packs.

ing playback. Be sure to set the charging.

be recharged and re-used for visible playback period decreases, -77 rechargeable batteries. of the unit before proceeding to

y pack which is new or which has months, the operating period may be affected by the properties of the battery. When recharging, use the battery pack on the original performance of the battery by repeating this cycle a few times. hours. Do not continue recharging

Alkaline battery operation

① Open the cover.

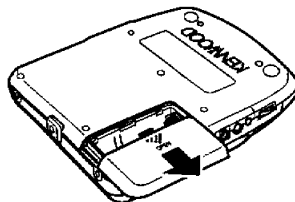

② Insert two LR6 alkaline batteries paying attention to the ⊕ and ⊖ polarity.

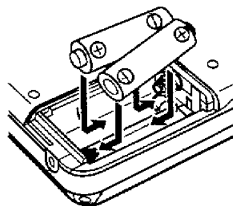

- Use commercially-available LR6 alkaline dry cell batteries.
- Always replace both batteries at a time.

③ Close the cover.

type	Blinking Timing	Treatment
Battery	When the battery is nearly exhausted	In a while, the power will be turned off automatically. Then recharge the battery pack.
	When the batteries are half exhausted	Playback is possible while the indicator is blinking.

Programming tracks in desired order

1 Enter stop mode.

- 1 Turn power ON.



- 2 Put the unit in stop mode.

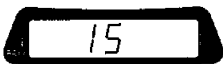

2 Press the P.MODE key.

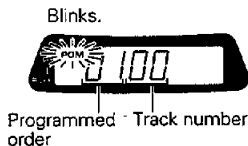
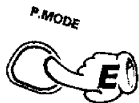

3 Select the desired track in the order you want.

- 1 Select a track...



- 2 And enter it.

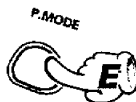

- Select other tracks in the desired order.
- Up to 24 tracks can be programmed.

4 Start playback.



F.



left position of the top cover until



Track number

disk begins.
to display the elapsed time of the
to the track number display.

use

The letter written on the hand in each illustration accompanying the text indicate the position of the pressed key on the unit.

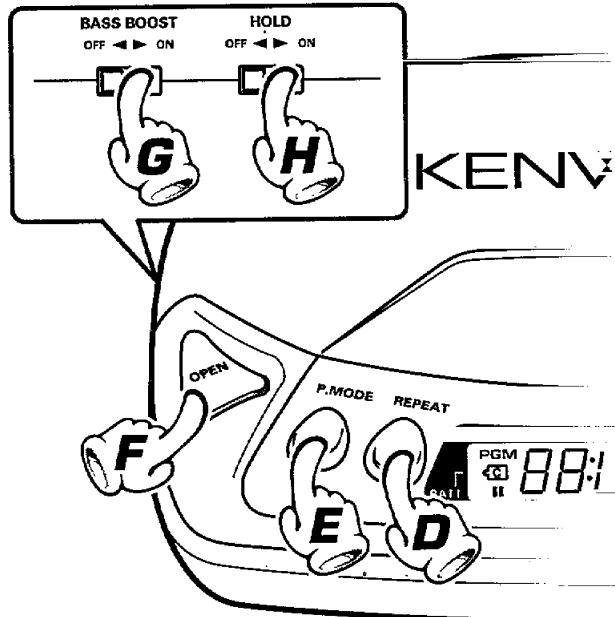

A ▶/II key

Press to play a disc, pause playback or switch power ON.

B ■ key

Press to stop the disc, turn power OFF or recharge the unit.

C SKIP/SEARCH (I-◀, ▶) keys

Press to skip tracks or search disc in the forward or backward direction.

D REPEAT key

Press for using various playback features.

E P.MODE key

Press for programmed playback.

Listening through speakers



Speakers with
built-in amplifier

Listening through car audio

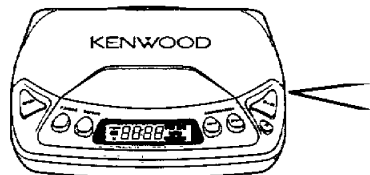
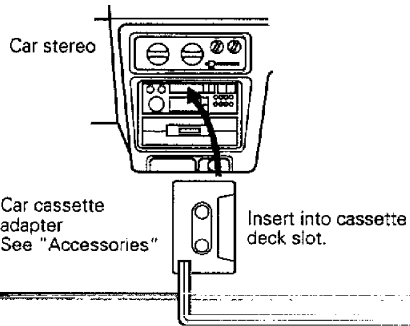

Car battery powered operation

- When the unit is not used, unplug the car battery adapter. (Otherwise, the car battery may run out, with some car models.)
- The plug may not match the cigar lighter socket of some car models.
- If the unit cannot be operated with the car battery adapter connected, suspect the possibility of a blown fuse. The fuse can be replaced by turning the electrode on the tip of the adapter plug. When replacing the fuse, be sure to use a fuse with a rating of 1 A.

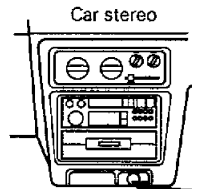

Connect to cigar lighter
socket.

THIS APPLIANCE TO RAIN OR MOISTURE.

ults, follow all warnings placed on the unit and adhere to the operating and use instructions.

13. **Cleaning** — Do not use volatile solvents such as alcohol, paint thinner, gasoline, or benzene, etc. to clean the cabinet. Use a clean dry cloth.
14. **Nonuse periods** — The power cord of the unit should be unplugged from the outlet when left unused for a long period of time.
15. **Damage requiring service** — The unit should be serviced by qualified service personnel when:
 - A. The power-supply cord or the plug has been damaged; or
 - B. Objects have fallen, or liquid has been spilled into the unit; or
 - C. The unit has been exposed to rain; or
 - D. The unit does not appear to operate normally or exhibits a marked change in performance; or
 - E. The unit has been dropped, or the enclosure damaged.
16. **Servicing** — The user should not attempt to service the unit beyond that described in the operating instructions. All other servicing should be referred to qualified service personnel.
17. **CAUTION (For the Canada)** — TO PREVENT ELECTRIC SHOCK DO NOT USE THE AC PLUG WITH AN EXTENSION CORD, RECEPTACLE OR OTHER OUTLET UNLESS THE BLADES CAN BE FULLY INSERTED TO PREVENT BLADE EXPOSURE.

Notes on using through car stereo

- In case of abnormality such as smoke production, immediately unplug the car battery adapter from the cigar lighter socket.
- Do not leave the products or batteries in the car, particularly above the dashboard, for this may lead to malfunction or damage due to solar heat.
- If the unit is connected to a car stereo using an audio cord, noise may sometimes interfere.

In case of abnormality, immediately press the open key to turn the power OFF, and unplug the AC adapter from the power outlet. Then please contact your nearest KENWOOD service center.

In case of difficulty

What seems to be a serious trouble may sometimes be due to a simple mistake. Before calling for service, check the items shown in the following table again. (If you request servicing due to the reasons shown in the table, the service may be charged in some cases.)

Symptom	Cause	Remedy
No operation occurs when operation keys are pressed.	<ul style="list-style-type: none">• The HOLD switch of the main unit is set to ON.• The batteries are exhausted.• The disc is placed upside down.• Condensation has occurred inside the unit.• The AC adapter or car battery adapter is disconnected.	<ul style="list-style-type: none">• Set the switch to OFF.• Replace both of the two dry cell batteries, or recharge the rechargeable batteries.• Place the disc with the labeled side up.• Leave the unit for about 1 hour before re-use.• Connect it properly.
No sound is heard from the headphones.	<ul style="list-style-type: none">• The headphones are connected incompletely.• The volume is set to the minimum position on the main unit.	<ul style="list-style-type: none">• Insert the plug securely into the PHONES jack.• Adjust the volume on the main unit.
Sound skips, or is interrupted.	<ul style="list-style-type: none">• The unit is subject to too strong vibration.• The disc is dirty.• The lens is dirty.• The headphone plug is dirty.• The batteries are weak.	<ul style="list-style-type: none">• Use it in a place with less vibration.• Clean it.• Clean it.• Clean it.• Replace or recharge the batteries.
Noise interferes.	<ul style="list-style-type: none">• The headphone plug is dirty.• The batteries are weak.• The headphones are connected incompletely.	<ul style="list-style-type: none">• Clean it.• Replace or recharge the batteries.• Insert the plug securely into the PHONES jack.
Rechargeable batteries cannot be recharged.	<ul style="list-style-type: none">• Commercially-available rechargeable batteries are used.	<ul style="list-style-type: none">• Use the exclusive rechargeable batteries (NB-77/NB-88).

Note

This system uses a microcomputer so it may malfunction due to external noise or interference. In such a case, unplug the power cord and remove the batteries, then plug the power cord again and insert the batteries again.

For rechargeable battery: Type NB-88, NB-77



ATTENTION

Nickel-Cadmium battery must be recycled or disposed of properly.
State laws may vary regarding the handling and disposal of Nickel-Cadmium batteries.
Please contact your Authorized KENWOOD Dealer for more information.

For the U.S.A.

CAUTION:

Use of controls or adjustments or performance of procedures other than those specified herein may result in hazardous radiation exposure.

In compliance with Federal Regulations, following are reproductions of labels on, or inside the product relating to laser product safety.

KENWOOD CORPORATION
2967-3, ISHIKAWA-CHO,
HACHIOJI-SHI,
TOKYO, JAPAN

KENWOOD CORP CERTIFIES THIS EQUIPMENT
CONFORMS TO DHHS REGULATIONS NO. 21
CFR 1040.10, CHAPTER I, SUBCHAPTER J.

Location: Bottom Panel

Controls and indicators

nit except for the OPEN key and
operation when the unit is put in

way, be sure to set the switch to
ON position. Operation is not
in the HOLD ON position.

Display

Battery indicator
which blinks when
the remaining battery
power is low.

Program mode
indicator which lights
when it is activated. Play mode
indicators

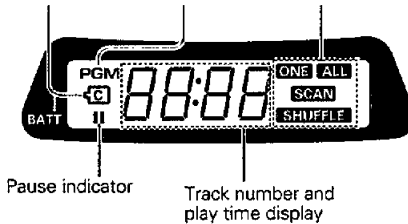

Specifications

Format

System Compact disc digital audio system
Laser Semiconductor laser

Audio

Frequency response 20 Hz ~ 20 kHz, ± 3 dB
Headphone output: 32 Ω , 1 kHz 10 mW + 10 mW

Power supply

External DC supply DC 6 V
Rechargeable battery DC 2.4 V
Commercially-available alkaline batteries (LR6, AA) $\times 2$ DC 3 V

Battery life (continuous repeat playback)

Commercially-available alkaline batteries (LR6, AA) $\times 2$ Approx. 6.0 hours
Rechargeable battery (NB-77) Approx. 3.0 hours

Dimensions (W \times H \times D) 129 mm \times 30 mm \times 150 mm
(5 - 1/16" \times 1 - 3/16" \times 5 - 7/8")

Weight (net) 250 g
(8.8 oz.)

Note:

KENWOOD follows a policy of continuous advancements in development. For this reason specifications may be changed without notice.

Accessories	DPC-361	
	For the U. K.	For other countries
Headphones	1	1
AC adaptor	1	1
Car cassette adaptor	1	—
Car battery adaptor	1	—